

FRONT ELEV.

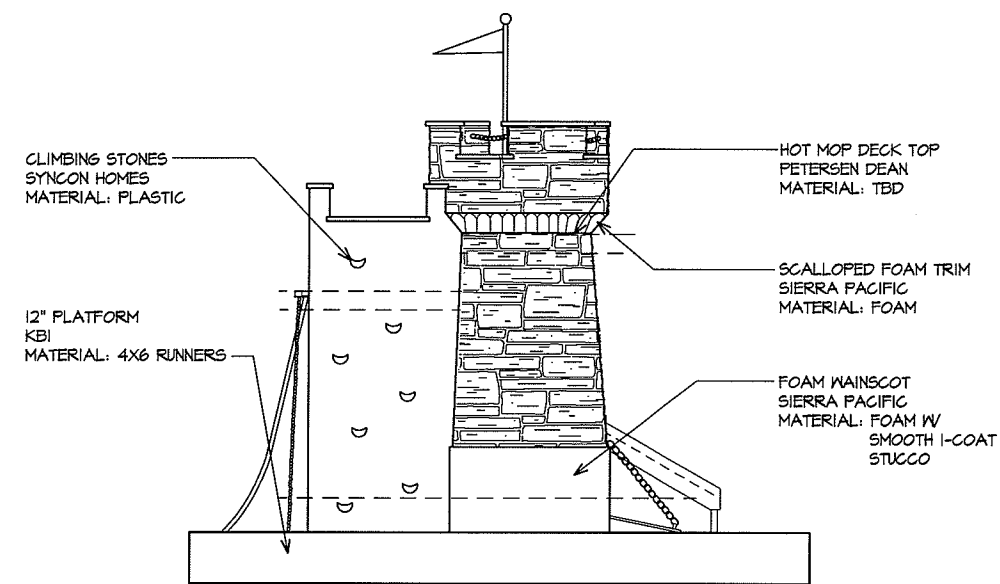

LEFT ELEV.

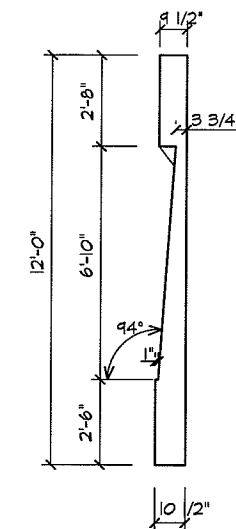

SECTION 'A'

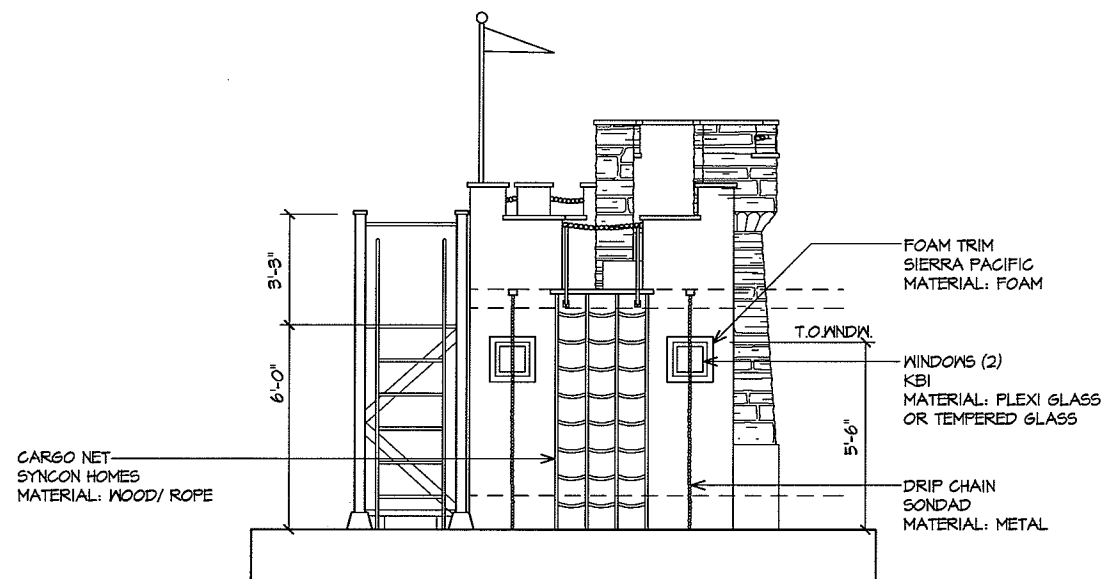

REAR ELEV.

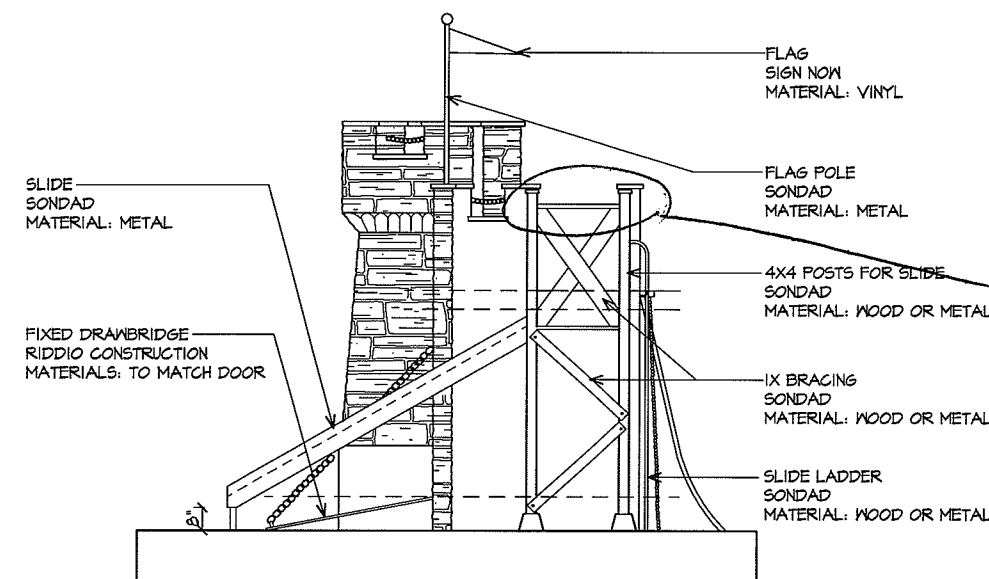

RIGHT ELEV.

*check Mt. of posts
all elev. don't
seem to match*

ADDITIONAL ITEMS:

EXTERIOR & INTERIOR SIDING SIERRA PACIFIC MATERIAL: MAHOGANY PANEL SHEETING T-1 SMOOTH	TREASURE CHEST DIAMOND "B" MATERIAL: WOOD	EXTERIOR BORDER LANDSCAPING GREAT ESCAPES MATERIAL: KEYSTONE
EXTERIOR PAINT RAYTECH MATERIAL: TBD	LANDSCAPING NKS MATERIAL: PER LANDSCAPING PLAN	
FLOORING DAVE'S DESIGN MATERIAL: TBD	MOAT NKS MATERIAL: TBD	

REVISIONS

DESCRIPTION	DATE	BY

**PLAYHOUSE
ELEVATIONS**

SCALE: 1/2" = 1'-0" PLOTTED: 4/26/2006
PATHNAME: J:\M5\PLAYHOUSE\DRAWING\PLAYHOUSE.DWG

JOB NO. 5-44 SHEET

DRAWN L1

CHECK

DATE

A.2

OF

FLOOR SHTB:
 3/4" APA RATED SHTB, W/ 6d @ 16" O.C. TO ALL FLOOR FRAMING MEMBERS, U.N.D.

TYPICAL SUBFLOOR FRAMING CONNECTION FOR JOIST, RIM, & BLOCKING CONNECTIONS:
 (4) 16d END NAILS OR (4) 16d TOE NAILS

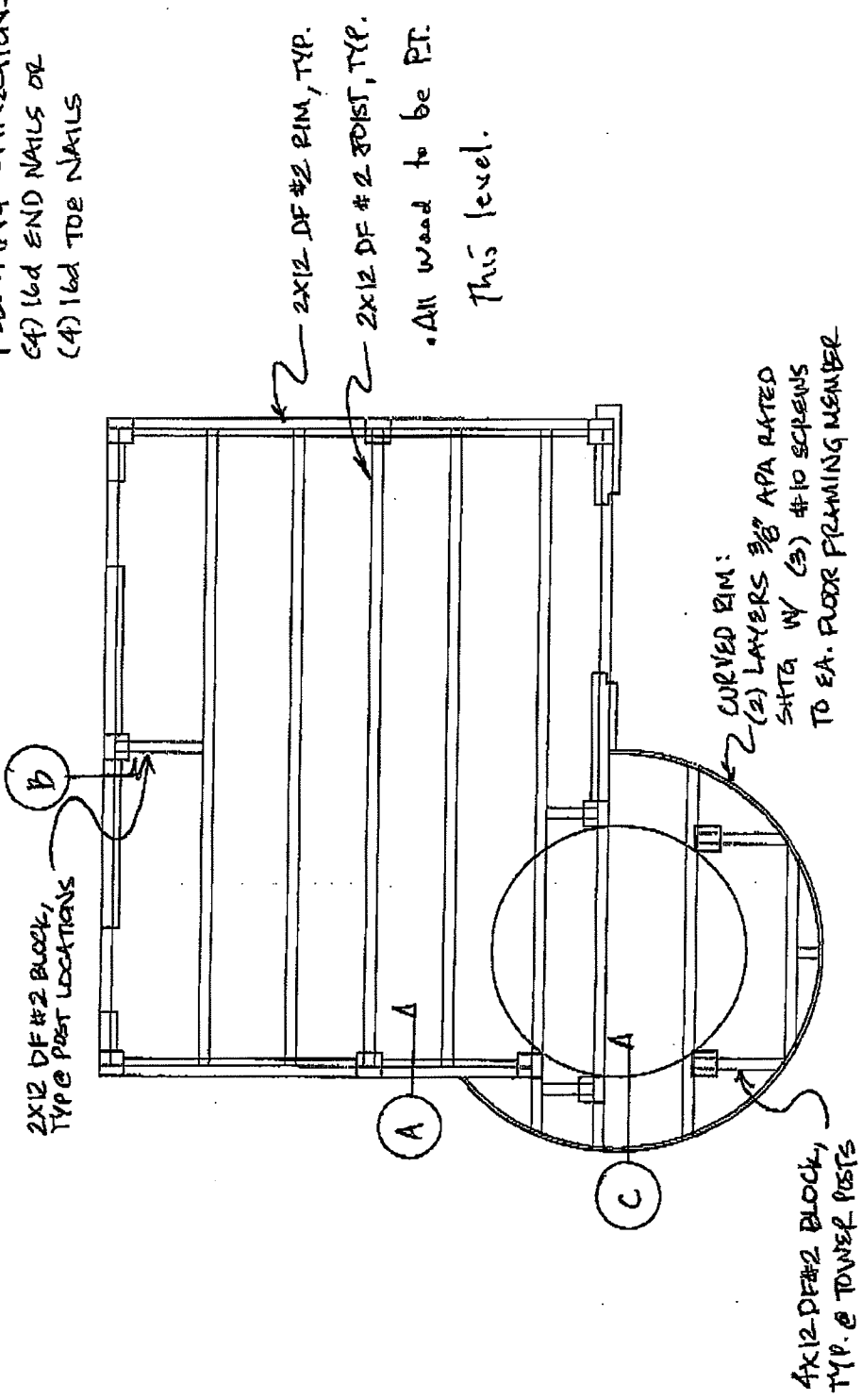

SUBFLOOR FRAMING PLAN.

FLOOR SHTG:
3/4" APA RATED SHTG W/
Ed @ 6" O.C. TO ALL FLOOR
FRAMING MEMBERS, U.N.O.

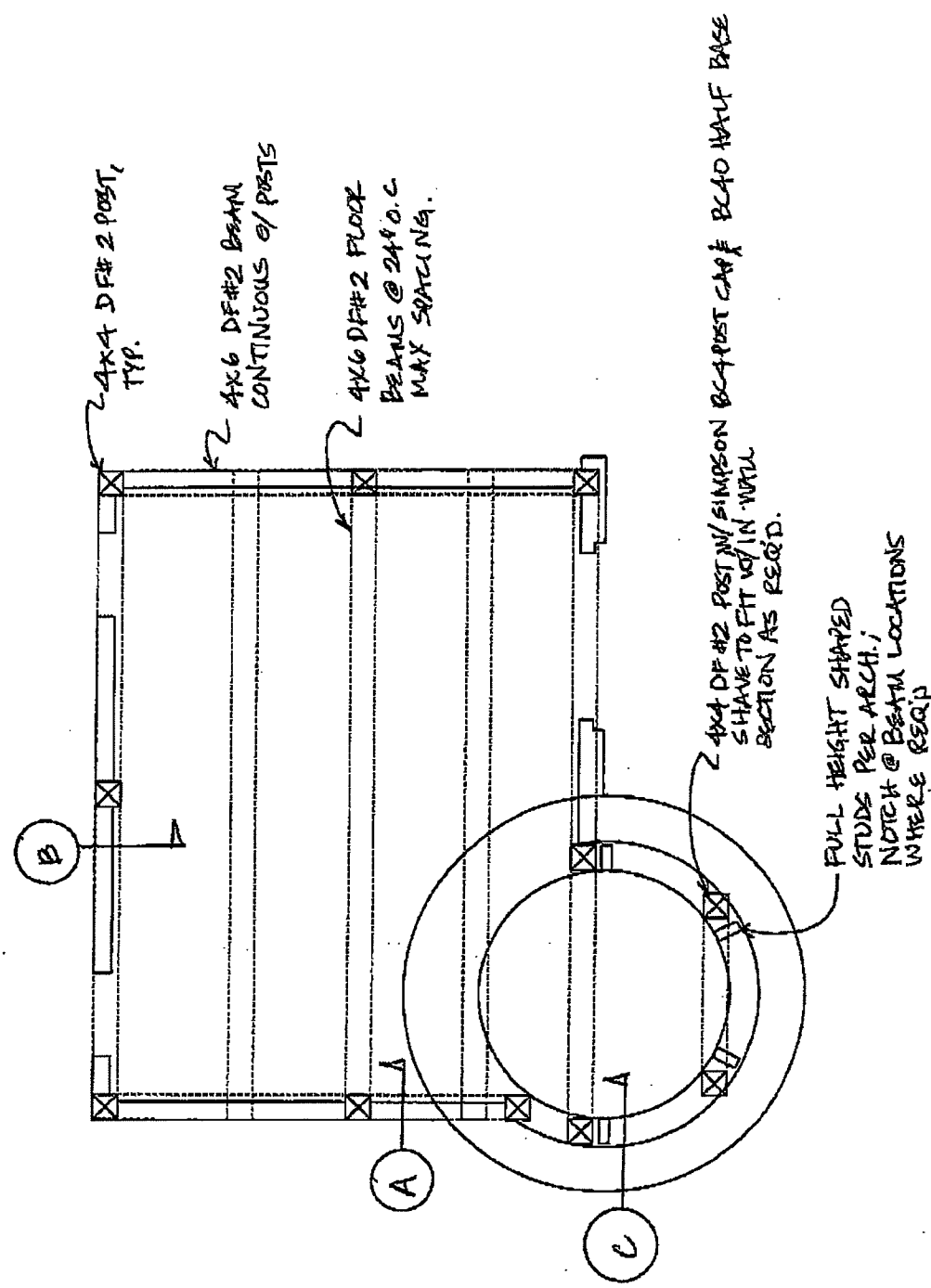

ROOF DECK FRAMING PLAN

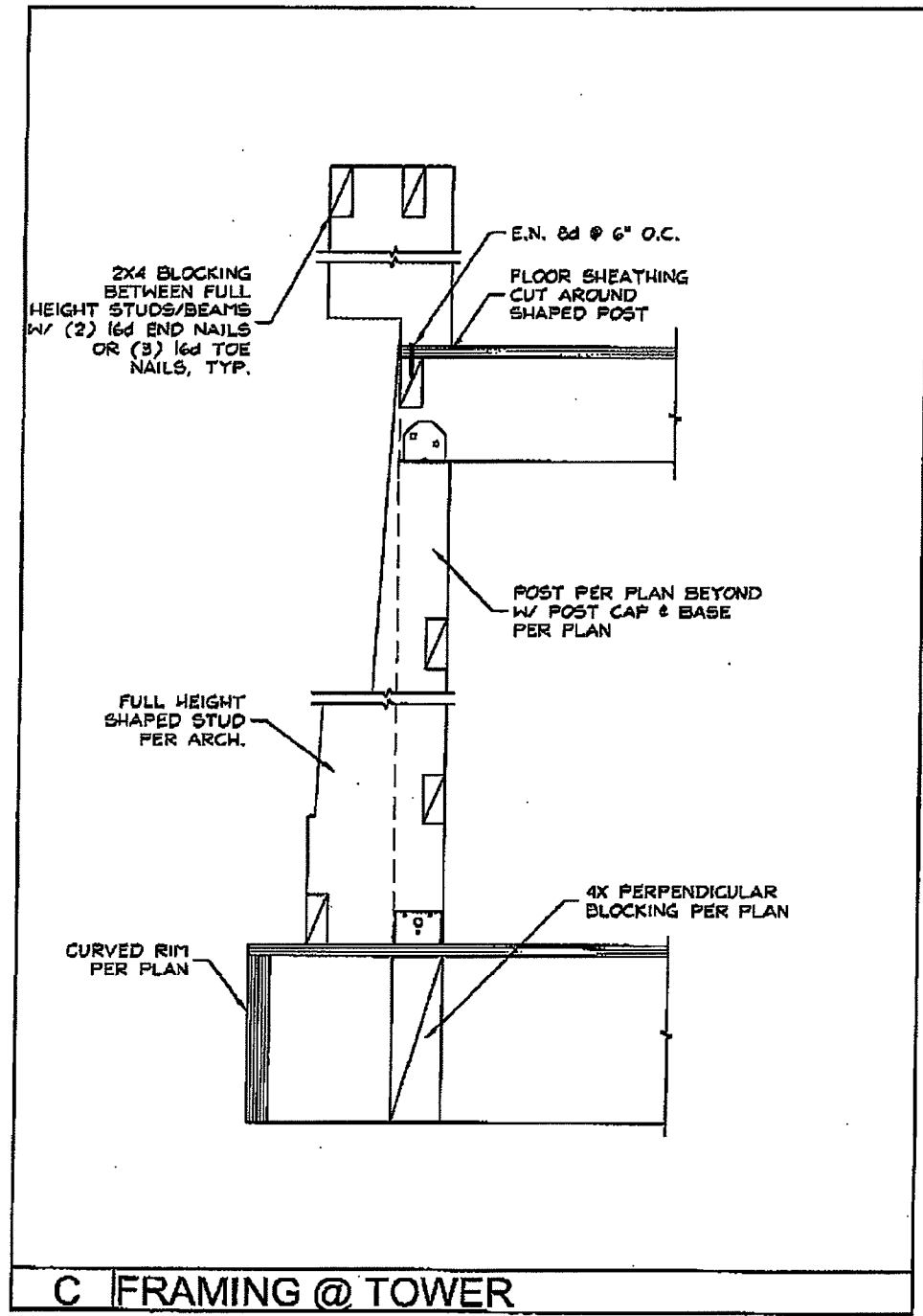

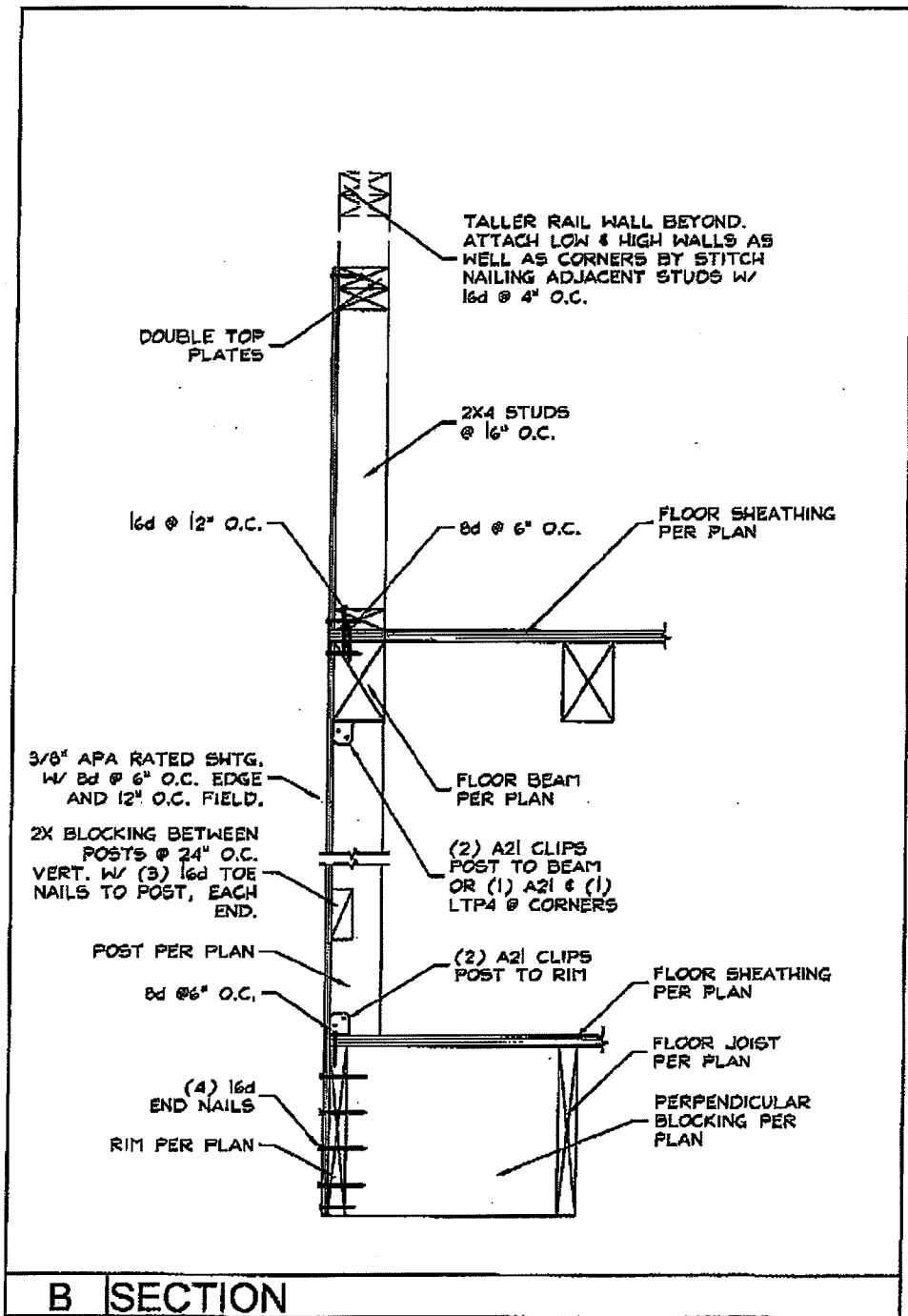

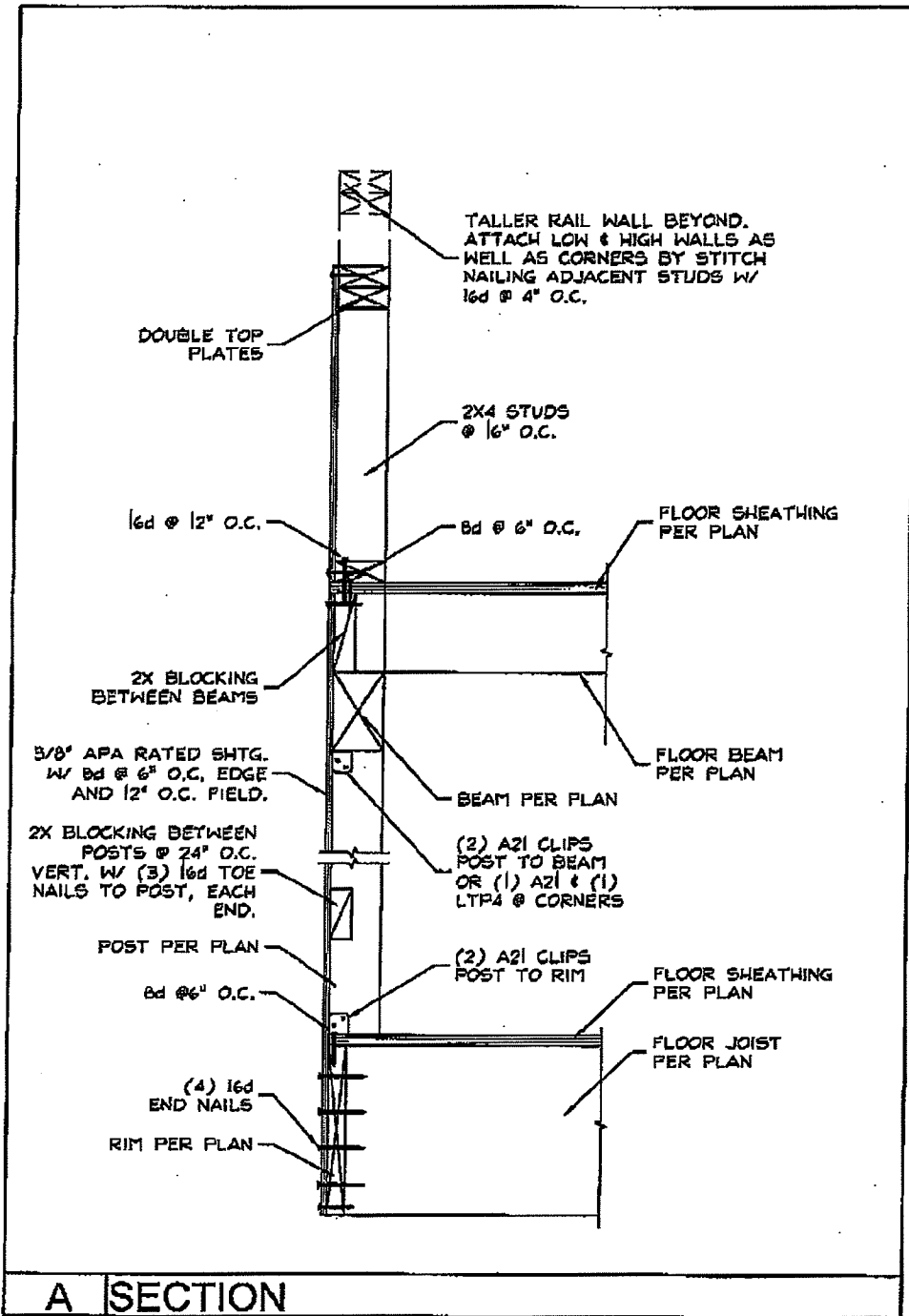

EXT: INTERIOR SIDING

SIERRA PACIFIC

MATERIAL: MAHOGANY PANEL SHEETING
T-1 SMOOTH?

TREASURE CHEST

DIAMOND "B"
MATERIAL: WOOD

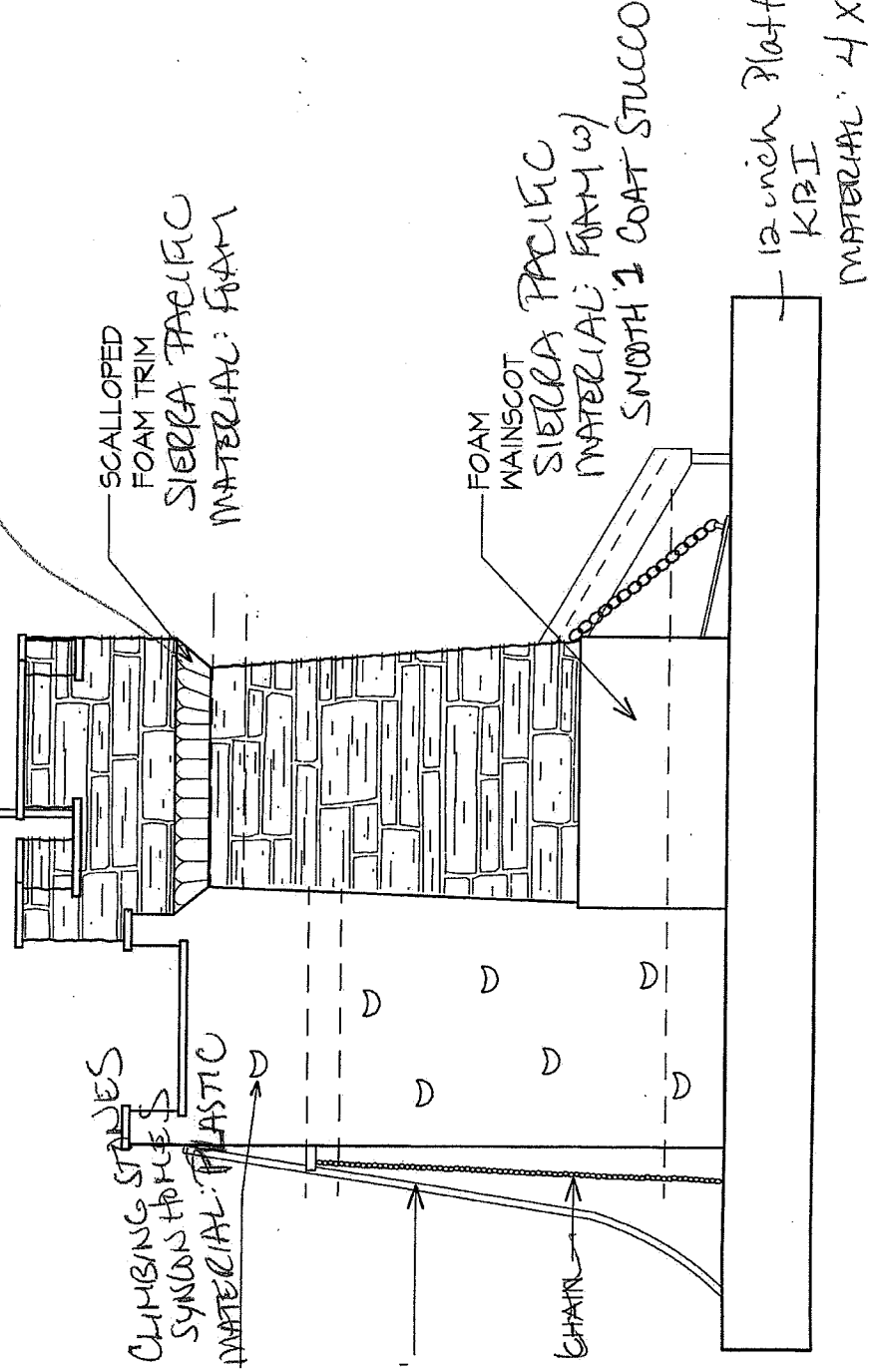

LANDSCAPING

NKS
MATERIAL: PER LANDSCAPING PLAN

EXT. BORDER LANDSCAPING

GREAT ESCAPES
DREAM, PLAY,
MATERIAL: KEYSTONE?
ROSEVIL

EXT. PAINT

RAYTECH

MATERIAL: TBD

Sym
H O N

9 1/2" MOAT
NKS
MATERIAL: TBD

3 3/4"

2'-8"

6'-10"

2'-6"

12'-0"

FLOORING
DAVE'S DESIGN
MATERIAL: TBD

FOAM WAINSCOT
SIERRA PACIFIC
MATERIAL: FOAM
SMOOTH 2 COAT STUCCO

94°

1"

12 inch Platform
KIBI

MATERIAL: 4 X 6 RUNNERS
10 1/2"

ARTIFICIAL LIGHT
SIGNALS

FLAG POLE
SONDAD
MATERIAL: METAL

4X4 POSTS AND SLIDE
SONDAD
MATERIAL: WOOD OR METAL

~~SLIDE~~
SONDAD
MATERIAL: METAL

1X WOOD BRACING
SONDAD
MATERIAL: WOOD OR METAL

SLIDE LADDER
SONDAD
MATERIAL: WOOD OR METAL

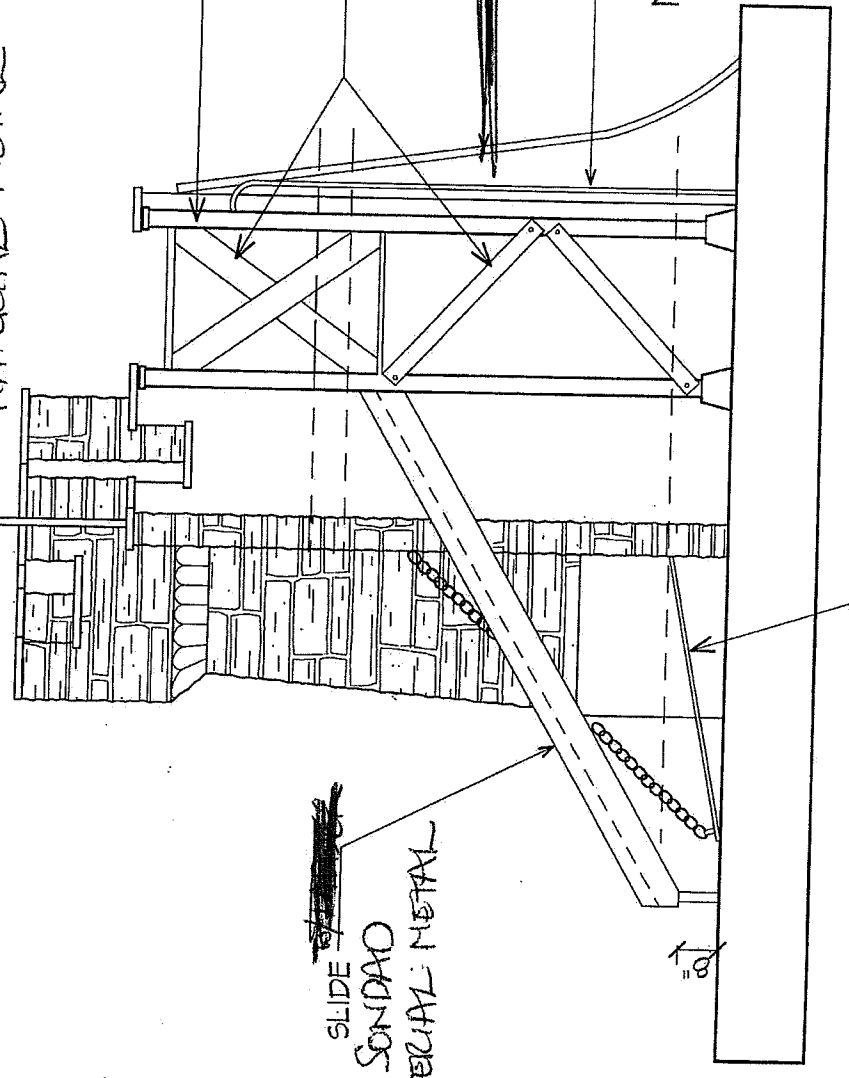

FIXED DRAWBRIDGE
RIDGEO CONST.
MATERIALS: TO MATCH DOOR

RIGHT ELEV.

Some kind of opening
for kids to get back
to clinic area.

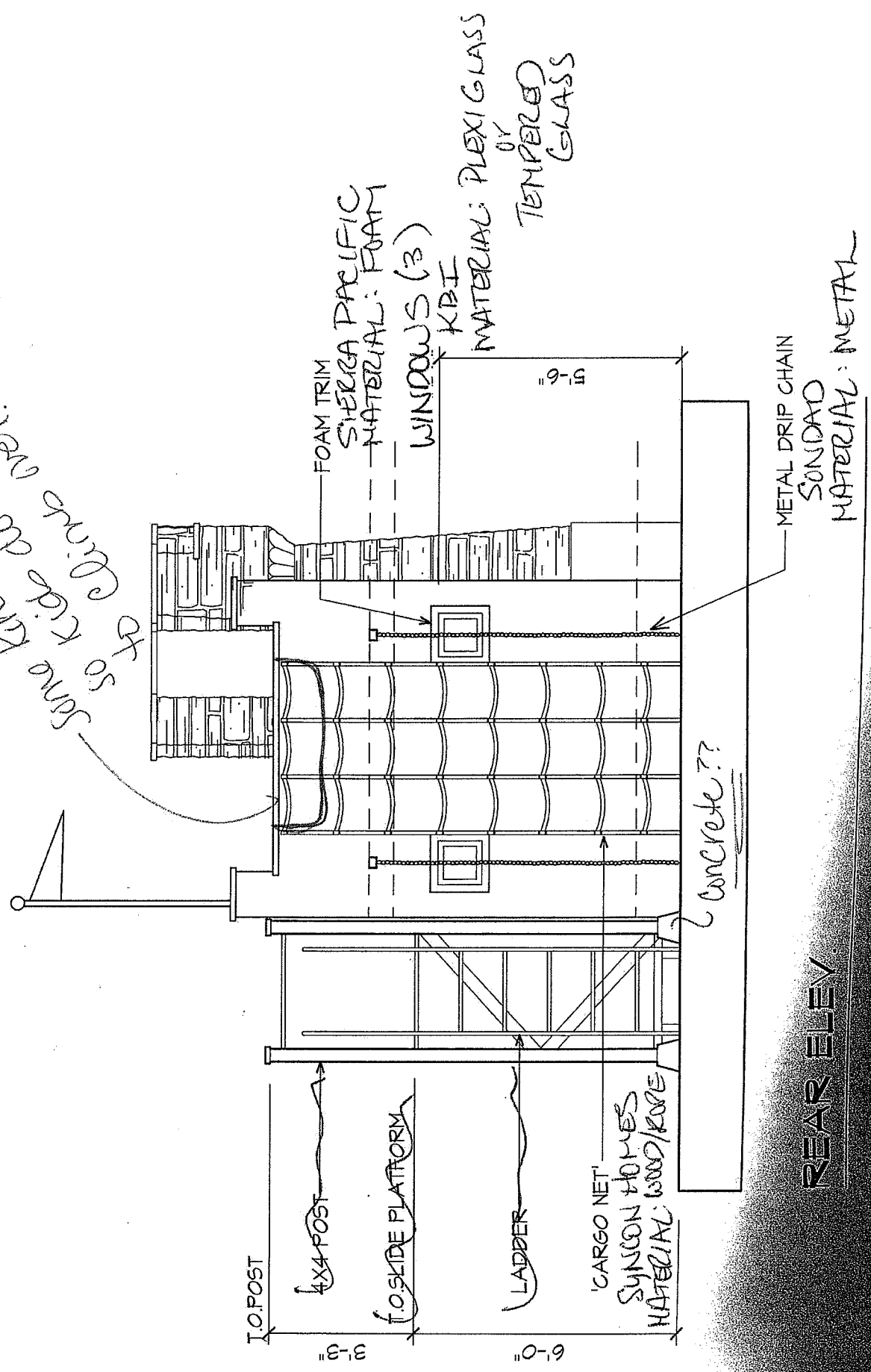

REAR ELEV

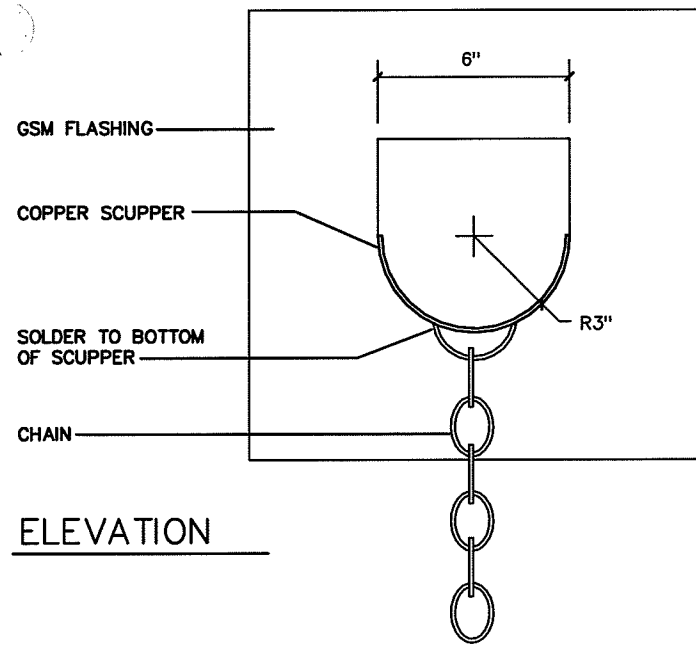

ELEVATION

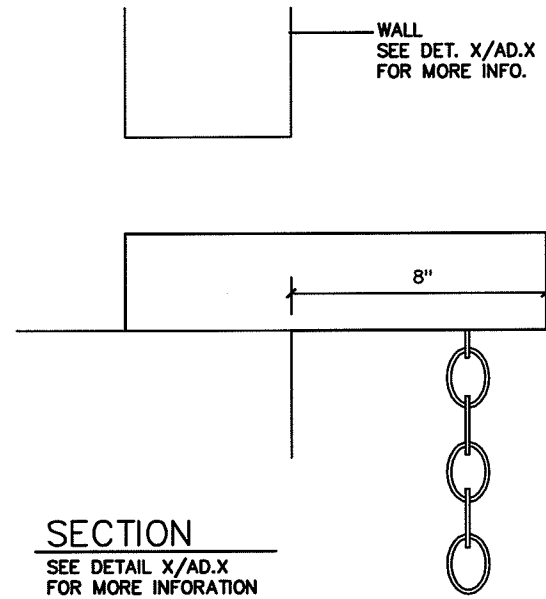

SECTION
SEE DETAIL X/AD.X
FOR MORE INFO.

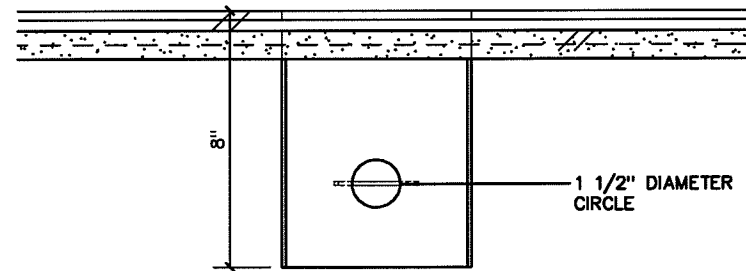

PLAN

SCALE: 3" = 1'-0"

SCUPPER

PATHNAME: J:\437PLAYHOUSE\DRAWINGS\DETAILS\SCUPPER.DWG

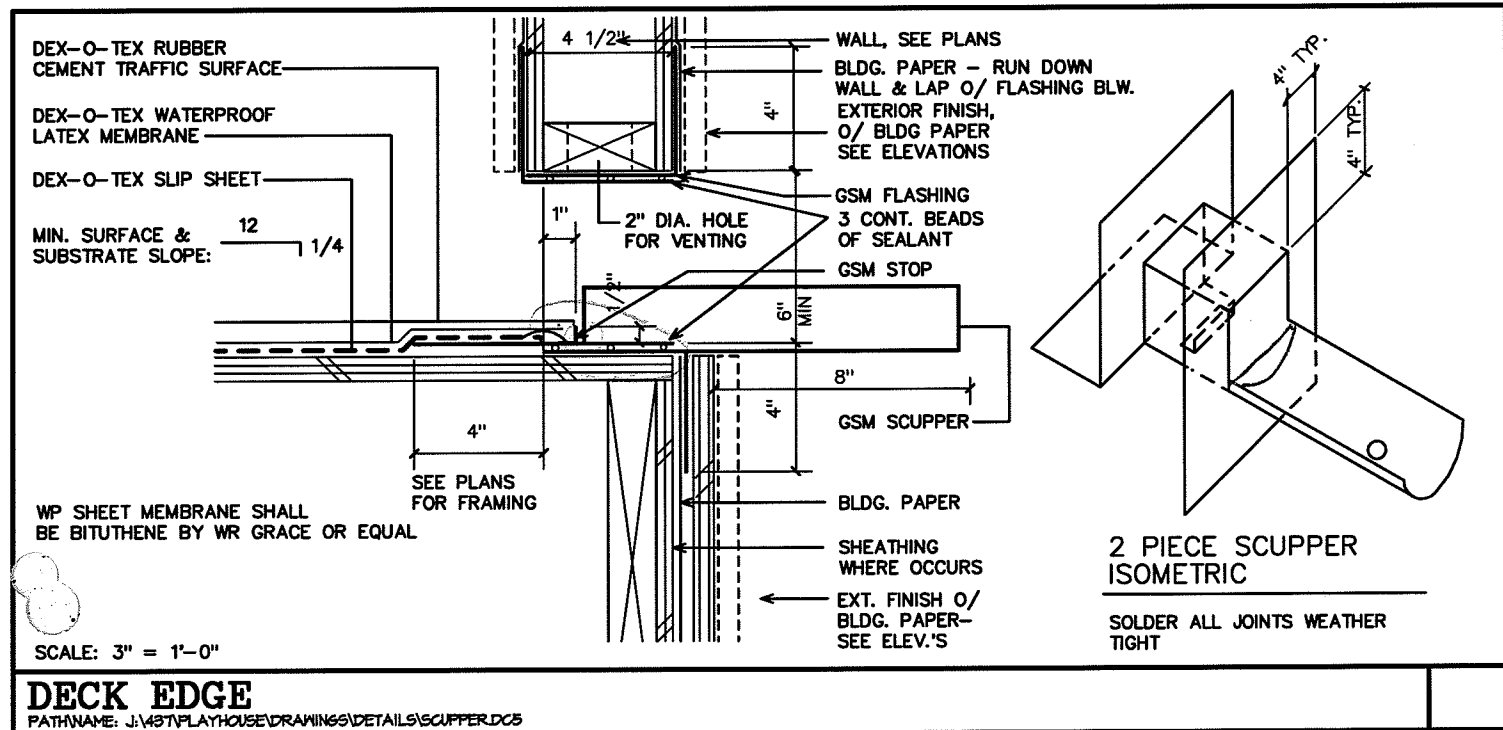

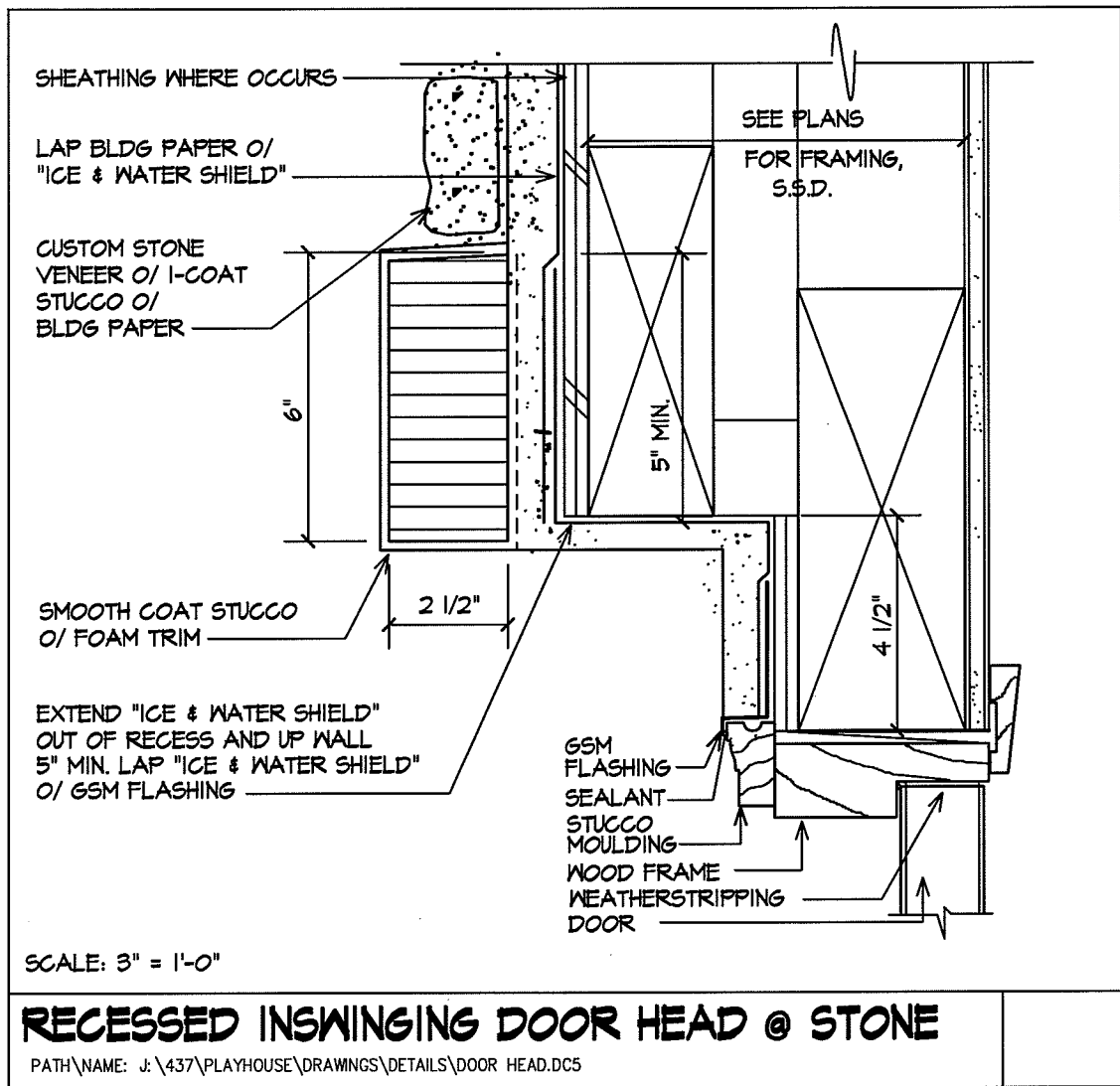

WINDOW SASH

STUCCO - PAINT TO
MATCH STONE

WATERPROOF MEMBRANE -
EXTEND UP & DOWN WALLS
5" MIN. & LAP O/ BLDG
PAPER BELOW. EXTEND UP
BEHIND WINDOW FLANGE

CUSTOM STONE VENEER
O/ 1-COAT STUCCO
O/ BLDG PAPER

SHEATHING WHERE OCCURS

2X - RIP
TO SLOPE

SCALE: 3" = 1'-0"

REC'D WINDOW SILL @ TURRET

PATH\NAME: J:\437\PLAYHOUSE\DRAWINGS\DETAILS\RECD SILL W_STONE.DCS

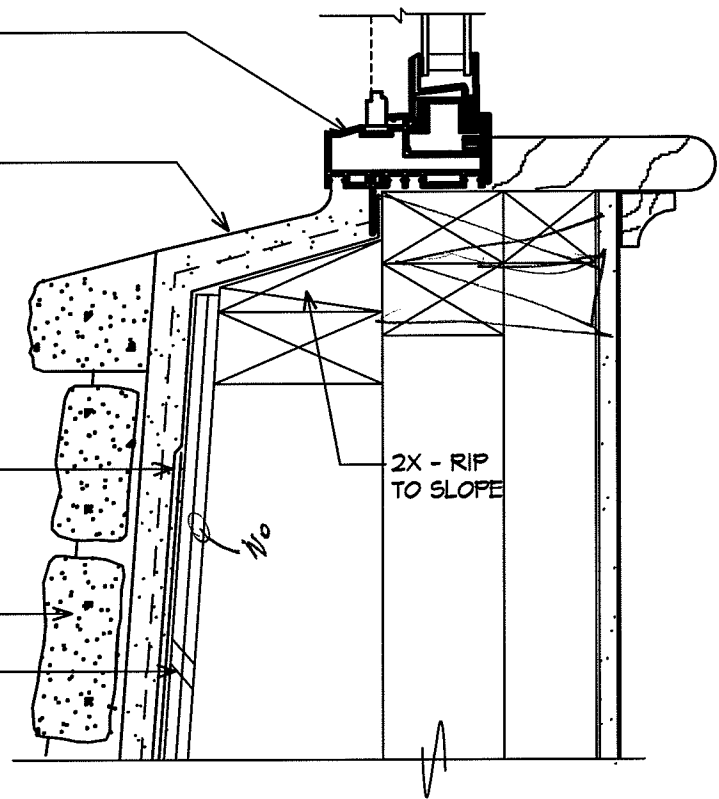

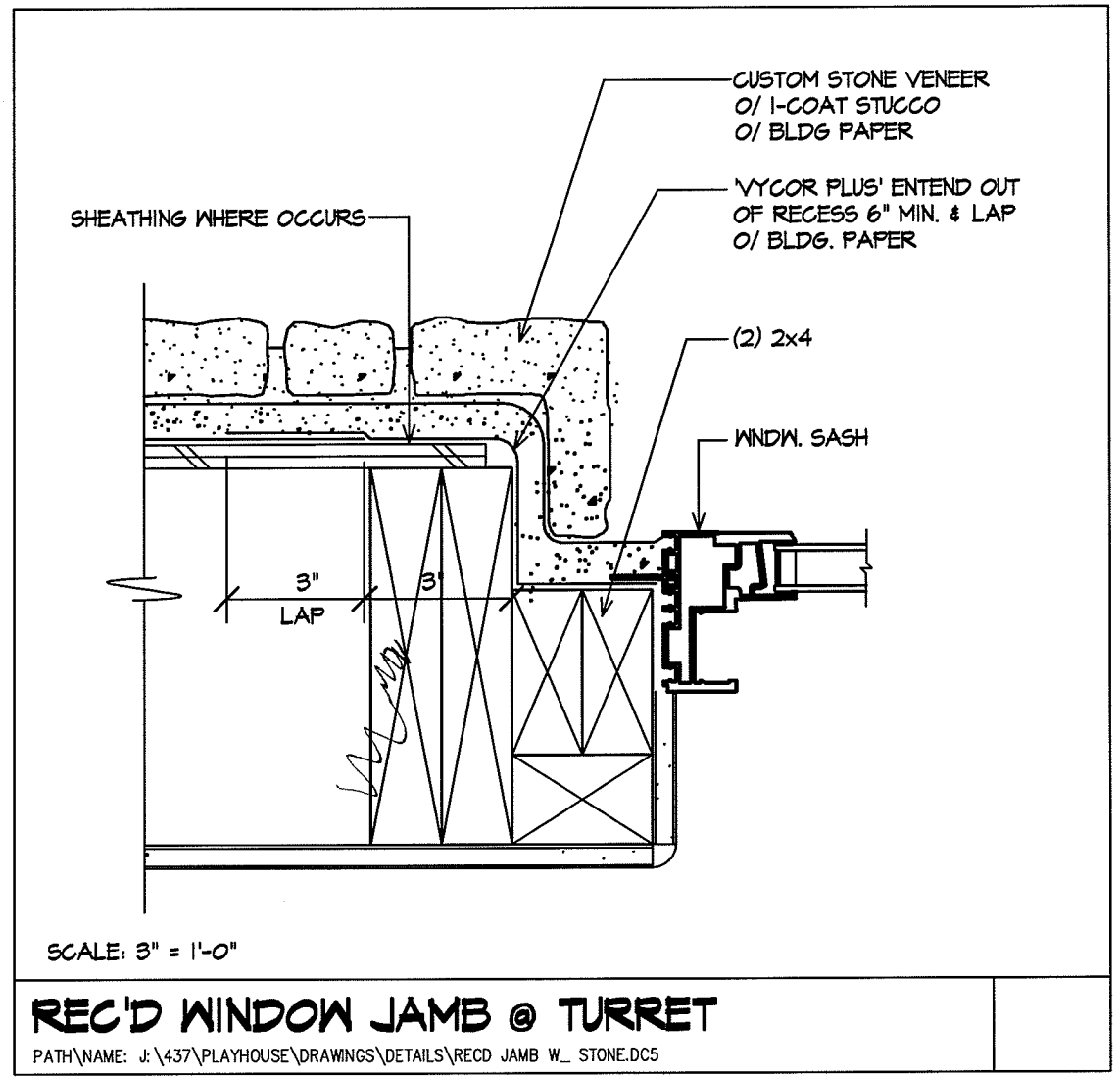

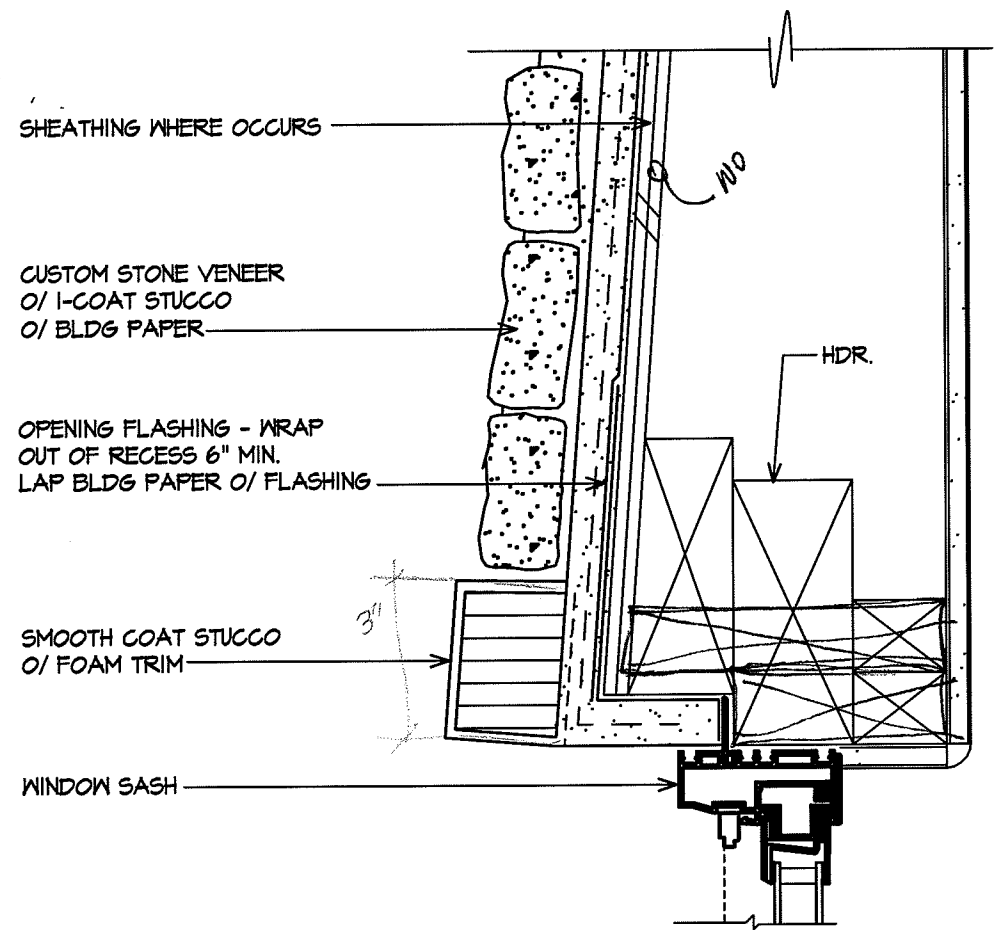

SCALE: 3" = 1'-0"

REC'D WINDOW HEAD @ TURRET

PATH\NAME: J:\437\PLAYHOUSE\DRAWINGS\DETAILS\RECD HEAD W_STONE.DCS